

Technical datasheet: KPX-G1205B-K6339

Specifications:

Operating Temperature	-20°C to +70°C
Storage Temperature	-30°C to +80°C
Rated Voltage	5VDC
Operating Voltage	4VDC to 8VDC
Max. Rated Current	30mA at 5VDC
Resonant Frequency	3.1kHz±0.5kHz
Min SPL	85dB/ 5VDC/ 10cm
Weight	2g
Case Material/Color	PBT/Black
Tone Nature	Continuous

Dimensions:

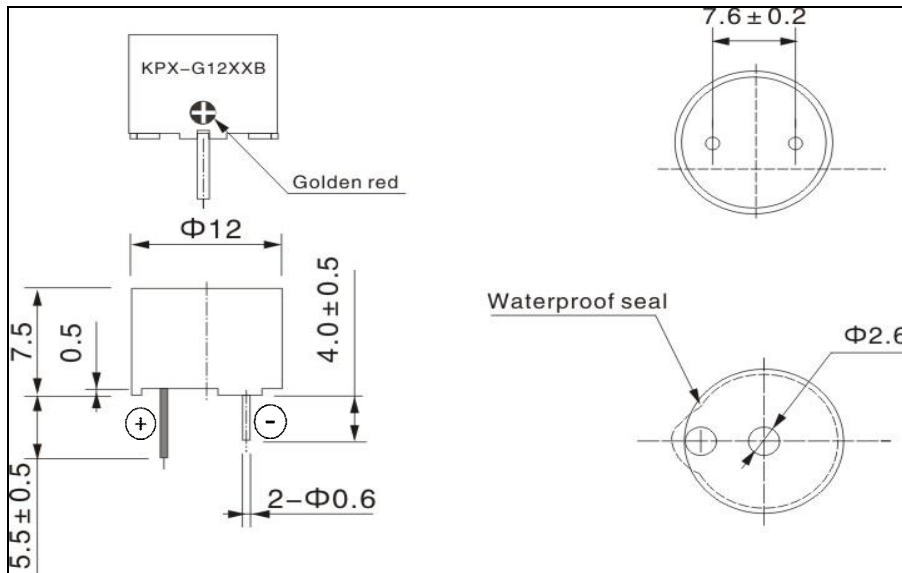

Frequency Response:

